

CAMELIA

180 x 85 h.50

Dati tecnici

Technical features

Max contenuto d'acqua Max water capacity	320 l
Peso a vuoto Dry weight	82 kg

Dati dimensionali

Dimensional features

Volume d'imballo Packaging volume	1.20 m ³
Peso spedizione Shipping weight	127 kg

Installazioni disponibili

Installations available

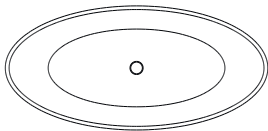

CENTRO STANZA
STANDALONE

Disegno tecnico / Technical drawing

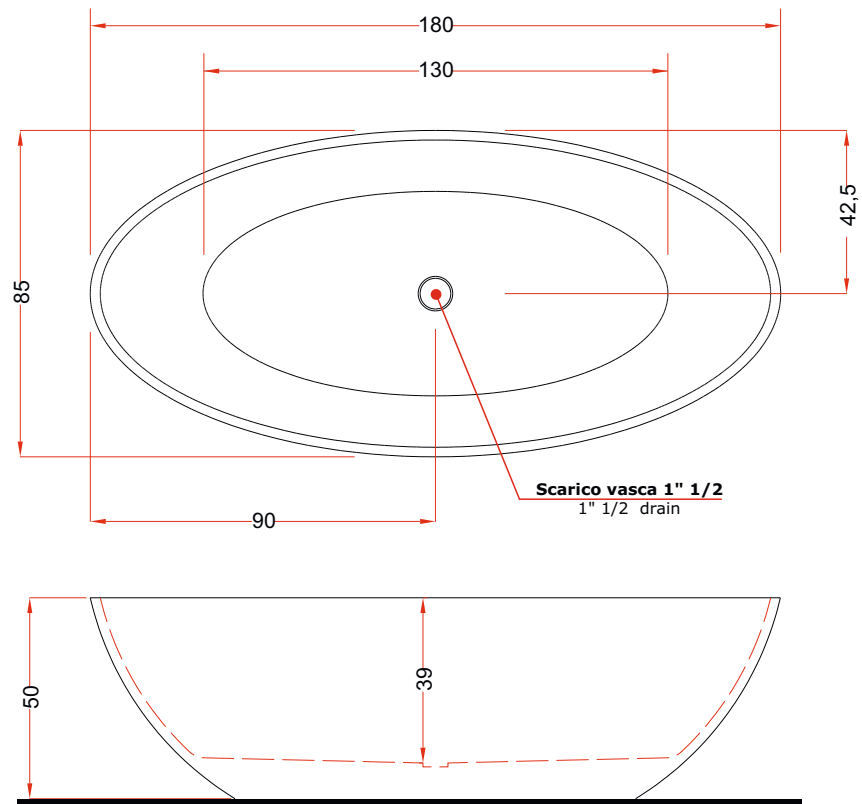

CAMELIA

180 x 85 h.50

Installazione idraulica - Rubinetteria vasca / Hydraulic installation - Bathtub taps

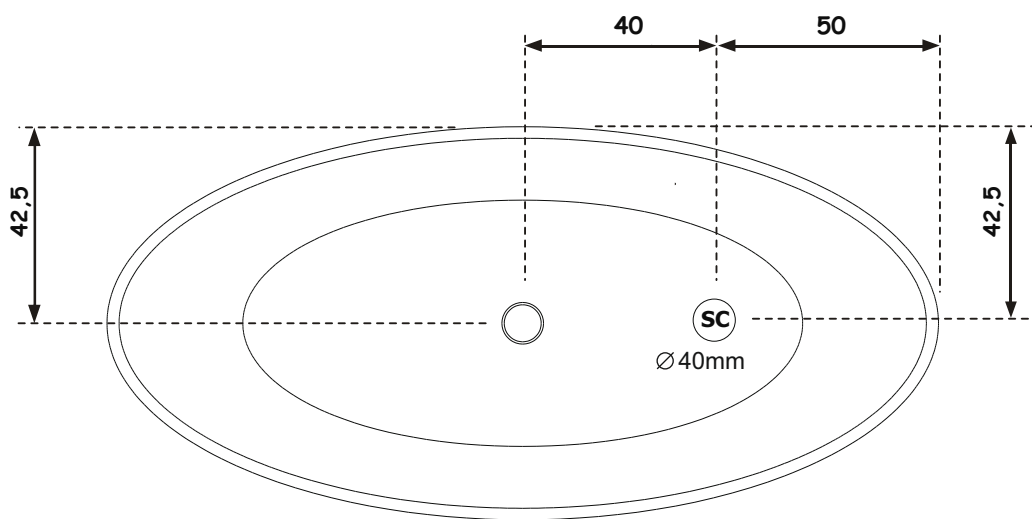

Scarico a terra consigliato
diametro 40mm - filopavimento



Recommended grounded drain
40mm diameter - on the floor

Appoggio a terra / Ground support

